



# **KRISHITEK**

## **INDUSTRIES PVT. LTD.**

### **POWER WEEDER/MINI TILLER**



**Model: POWERTEK 5.5WP**



## **Maintenance Manual**

---

➤ **MAINTENANCE :**

 <b>WARNING</b>	<p>Do not touch rotating blade.            Stop the engine and unplug the spark plug before doing any repairs or maintenance. For four stroke engines, check regularly the oil level and add some oil or replace it if necessary.            Frequently check the weeder and ensure that all deposits are removed from the weeding blade.            For security and condition - Check the blade, in order to obtain a good cut, the blade should always be sharp and well balanced. At regular intervals, check the tightness of all nuts, bolts and screws.            If the blade hits an obstacle, stop the weeder, assess for damage. If beyond safe repair you must replace it.</p>
 <b>CAUTION</b>	<p>Refuel in a well-ventilated area with the engine off.</p>
 <b>CAUTION</b>	<p>Whilst carrying out maintenance you must wear correct PPE, suggested PPE but not limited too;</p>



➤ **Cleaning.**

- Keep the machine clean. Do not use chemical solvent to clean it.
- Remove all debris and remnants of other materials from the blades and machine.

➤ **Air Filter.**

- Your machine will run more efficiently if you clean the air filter after every 8 working hours.
- Remove filter, check for contamination and clean as required.
- Clean filter by blowing air through it using an air gun not exceeding 30psi.
- Never use a brush to clean the filter it will only drive dirt into the fibres of the filter.
- Wipe dirt from the air cleaner body by using a moist rag, be careful to prevent dirt or debris entering the air ducts into the carburettor.

 <b>CAUTION</b>	<p>Using old or stale fuel will impair starting and running of machine.            Make sure that the machine has fresh unleaded fuel and always remove fuel before storing for long periods.</p>
--	---

➤ **Spark plug.**

- Spark plug type (or equivalent) F7RTC.
- To check spark plug, remove spark plug cap and remove spark plug using the supplied spark plug wrench.
- Clean the spark plug electrode also making sure that there is no damage to the insulator or electrode.
- The spark plug gap should be 0.70mm to 0.80mm adjust as necessary by carefully bending side electrode.
- Install cleaned and adjusted spark plug by hand to avoid cross-threading.
- After spark plug seats then tighten as necessary but avoid over-tightening.
- Attach spark plug cap.

 **NOTE**

Loose spark plugs can overheat and damage engine.

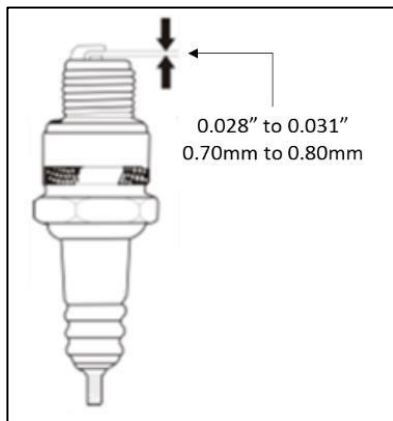

Spark plug



Spark plug cap

➤ **The Tiller Blade.**

- The blade is made of pressed steel, in order to obtain a good cut sharpen the blade frequently, around every 25 hours of work.
- Make sure that the blade is always well balanced.
- To remove the blade, unscrew the bolt, check the blade support and change all spare parts if they are worn out or damaged.

➤ **Storage.**



 **NOTE**

When storing any type of power equipment in an un-ventilated or material storage shed, care should be taken to rust-proof the equipment. Using a light oil or silicone, coat the equipment, especially cables and all

- The following steps should be taken to prepare your weeder for storage:
- Following the final use of the season, drain the fuel tank and run engine until it stops, to drain the carburettor of fuel.
- Clean and lubricate weeder thoroughly.
- Lightly coat weeder cutting blade with oil to prevent rusting. Store mower in a dry, clean area.

➤ **TROUBLESHOOTING.**

- Engine Troubleshooting - N.B. Where necessary all corrective actions should be carried out by suitably qualified person/s.
- If the starter rope becomes disconnected from the rope guide on handle, disconnect the spark plug cap. Depress the blade control handle and pull the starter rope out from engine slowly and re-engage in guide. Re connect spark plug cap.

<b>PROBLEM</b>	<b>PROBABLE CAUSE</b>	<b>CORRECTIVE ACTION</b>
<b>1. Machine will Not start.</b>	Does the machine have fuel?	Fill with fuel.
	Is the throttle set to stop?	Set throttle to 
	Is the HT lead on correctly?	Check HT lead is pushed onto spark Plug correctly.
	Is the Spark plug clean and correctly Set?	Clean and adjust.
	Spark plug gap too large.	Set gap to 0.7 mm to 0.8 mm
	Spark plug defective.	Replace
	Incorrect/Stale fuel.	Drain tank/carburettor and replace With fresh unleaded petrol.
<b>2. Machine runs But stutters.</b>	Choke set incorrectly.	Set choke to correct position. 
<b>3. Engine does not reach full speed</b>	Air filter dirty.	Clean and replace as necessary.
	Spark plug dirty.	Clean and replace as necessary.
	Spark plug gap too large.	Set gap to 0.7 mm to 0.8 mm.
	Incorrect/Stale fuel.	Drain tank/carburettor and replace With fresh unleaded petrol.
<b>4. Machine is difficult to control when weeding (machine jumps or moves forward)</b>	Incorrect depth regulator bar adjustment.	<ul style="list-style-type: none"> <li>• Lock wheels in tilling position</li> <li>• Lower the depth regulator bar.</li> </ul>
<b>5. Tines turn, machine does not move</b>	Incorrect depth regulator bar adjustment.	Lower the tines for deeper tilling by raising the depth regulator lever.
<b>6. Excessive heat builds up in transmission /tine area during weeding.</b>	<ul style="list-style-type: none"> <li>• Oil level is below bottom line.</li> <li>• Tine area choked up with vegetation.</li> </ul>	<ul style="list-style-type: none"> <li>• Check transmission fluid and fill if needed.</li> <li>• Remove vegetation from tines.</li> </ul>

➤ **ATTENTION OF OPERATING ENGINE:**

➤ **RUNNING – IN OF NEW ENGINE:**

- If your engine has not breaking in yet,improper usage will shorten the life of engine.the initial 20 hours is the break-in-period.
1. **RUNNING IN FOR 5-MINS AFTER FIRST START.** Running with low speed and low load before the engine gets hot. Avoid running with high speed and full load speed and no load.
  2. **AVOID RUNNING WITH OVERLOAD.** During break-in-period, the engine can't run with full load,but can run with 3600 rpm and 50% load.
  3. **CHANGE ENGINE OIL REGULARLY.** After working for 20 hrs,change the oil when engine is still warm,otherwise it will be difficult to drain the residual oil in the engine.
  4. **SAFETY INSTRUCTIONS :**

# DOs

- ✓ Do visual check before starting every time.
- ✓ Keep agriculture weeder clean.
- ✓ Do use recommended fuel and lubricants only.
- ✓ Do check fuel level.
- ✓ Do check air intake filter oil level.
- ✓ Do check engine oil and gear oil levels.
- ✓ Do check for any leakage.
- ✓ Do check decompression knob before starting.
- ✓ Do check gear in neutral position before starting.
- ✓ Do use recommended attachments only.
- ✓ Do maintain distance of 1ft from buildings and other equipments when operating, to avoid any accidents.
- ✓ Only operator with knowledge of machine and its operation must be permitted to operate agriculture weeder.
- ✓ Let agriculture weeder cool down before storing indoors.

# DON'Ts

- ✘ Don't overflow the fuel, but also never let fuel tank run out empty.
- ✘ Don't use adulterated fuel.
- ✘ Don't smoke or allow flame or spark where agriculture weeder is refueled or where fuel is stored.
- ✘ Don't inhale exhaust for it can contain poisonous carbon monoxide.
- ✘ Don't run agriculture weeder without adequate ventilation.
- ✘ Don't lean/tilt weeder more than 20°, otherwise fuel may spill.
- ✘ Don't cover agriculture weeder top so as to avoid fire.
- ✘ Don't touch muffler/exhaust, as it gets hot when operating and stays hot for sometime after stopping.
- ✘ Don't delay on service schedules.
- ✘ Don't operate weeder continuously more than 2hrs.30mins for any given operation
- ✘ Give break of 20mins.
- ✘ Don't take any alterations in design, operations and functioning of agriculture weeder other than company's recommendation.

➤ **SERVICE:**

- Your krishitek power weeder is designed to provide many hours of trouble free service. Regular scheduled maintenance will help your power weeder achieve that goal. If you are unsure or are not equipped with the necessary tools, you may want to take your unit to a krishitek service dealer for servicing. To help you decide whether you want to DO IT YOURSELF or have the krishitek dealer do it, each maintenance task has been graded. If the task is not listed, see your krishitek dealer for servicing.
- **SKILL LEVEL**
- **LEVEL 1** = Easy to do. Most required tools come with unit.
- **LEVEL 2** = Moderate difficulty. Some specialized tools may be required.
- **LEVEL 3** = Experience required. Specialized tools are required. Recommended that the unit be returned to your krishitek dealer for servicing.
- Switch off the engine before maintenance and wait for the engine to cool down.

Working intervals and maintenance contents	Every day	Work with weeder under load for 8 hrs	Work for one month or 20 hrs	Work for 6 months or 100 hrs	Every year or 200 hrs	Per 2 years or 500 hrs	REQUIRED SKILL LEVEL
Check and tighten nuts and bolts	✓						1
Check and refuel lube	✓						2
Check and change lube		✓ (First time)	✓ (Second time)	✓ (Third time or more)			2
Check if there is oil leakage	✓						1
Clean mud, grass and oil stain	✓						1
Debug malfunction	✓						3
Adjust operation parts	✓						3
Friction plate of clutch						✓	3
Air cleaner (Check & Clean)	✓						
Spark Plug (Check & Clean)					✓		
Gears and bearings					✓		3

➤ **SERVICING YOUR ENGINE :**

**MAINTENANCE SCHEDULE**

REGULAR SERVICE PERIOD (3) Perform at every indicated month or operating hour interval, whichever comes first.		Each Use	First Month or 20 Hrs	Every 3 Months or 50 Hrs	Every 6 Months or 100 Hrs	Every Year or 300 Hrs
ITEM						
Engine oil	Check level	o				
	Change		o		o	
Reduction case oil (applicable types)	Check level	o				
	Change		o		o	
Air cleaner	Check	o				
	Clean			o (1)	o *(1)	
	Replace					o **
Sediment cup	Clean				o	
Spark plug	Check-adjust				o	
	Replace					o
Spark arrester (applicable types)	Clean				o (4)	
Idle speed	Check-adjust					o (2)
Valve clearance	Check-adjust					o (2)
Combustion chamber	Clean	After every 500 Hrs. (2)				
Fuel tank & filter	Clean				o (2)	
Fuel tube	Check	Every 2 years (Replace if necessary) (2)				

- \* • Internal vent carburetor with dual element type only.
- Cyclone type every 6 months or 150 hours.

**INTERNAL VENT CARBURETOR TYPE**

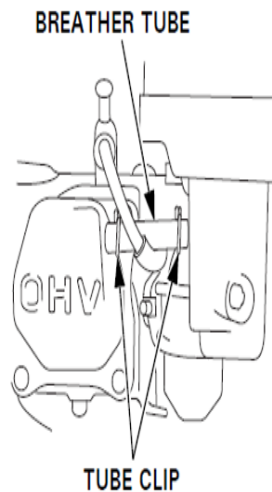

**STANDARD TYPE**

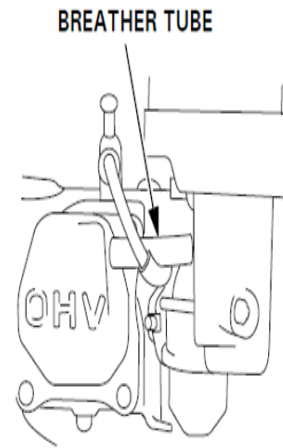

- \*\* • Replace paper element type only.
- Cyclone type every 2 years or 600 hours.

- (1) Service more frequently when used in dusty areas.
- (2) These items should be serviced by your servicing dealer, unless you have the proper tools and are mechanically proficient. Refer to the Honda shop manual for service procedures.
- (3) For commercial use, log hours of operation to determine proper maintenance intervals.
- (4) In Europe and other countries where the machinery directive 2006/42/EC is enforced, this cleaning should be done by your servicing dealer.

Failure to follow this maintenance schedule could result in non-warrantable failures.







## **Krishitek Industries Pvt. Ltd.**

Plot No.40, Prime Industrial Park, Santej, Ta-Kalol, Di-Gandhinagar  
Gujarat, India, Pin-382721  
Contact No.:- 09925012936, Email :- info@krishitek.com  
www.krishitek.com